



2021+ CHEVY TAHOE

ORDERING GUIDE

JOTTOPUBLICSAFETY.COM

DGS CONTOUR CONSOLE

(DUTY GEAR SAVER)

The Chevy Tahoe (2021+) DGS Contour Console (Duty Gear Saver) has a dash contouring shape and will fit all necessary communication and lighting equipment and extra room for your duty weapon. Installation is quick and easy. No drilling required. Console comes with 20" of faceplates. This Tahoe Contour Console has been designed to accommodate our Mamba Mount (425-0150), Computer Side Mount (425-5542) with mounting locations for our Side Mounted Armrest (425-1849), and Rear Mounted, Side Hinged Armrest (425-0040).



425-6687

Length37.51" Height.....10.15"
 Width.....13.51" Weight22.75 lbs
 Rated Capacity20" of face plates

- DGS Design (extra room for duty weapon)
- (1) 12V Outlet
- (1) Magnetic Mic
- Relocates OEM USB/AUX and 110 Outlet
- Driver's Side Knockout for Mounting Speaker
- Passengers Side Fuse Block w/Cover/Access Panel



CONTOUR CONSOLE

With the development of the JOTTO DESK® Contour Console line in 2001, traditional console design was revolutionized. Rather than simply a box shoved between the seats and crammed with equipment, Jotto Desk evaluated the vehicle and designed consoles based upon what the vehicle would allow combined with the agencies needs. There have been many attempts to replicate our design, but none can compare.



425-6569

Length 37.60" Height..... 10.15"
 Width..... 13.15" Weight 25.5 lbs
 Rated Capacity 20" of face plates

IPB CONTOUR CONSOLE (INTEGRATED PRINTEK BROTHER)

The Chevy Tahoe (2021+) Integrated Printek Brother Contour Console (IPBCC) has an unique feature of this console design is that it allows for integration of a PrintekMobile I80 or Brother PJ6/7 printer and paper roll for easy access for the officer. Installation is quick and easy. No drilling required. Console comes with 14" of faceplates.

Length 37.60" Height..... 10.15"
 Width..... 13.15" Weight 27.05 lbs
 Rated Capacity 14" of face plates

425-6678



JOTTO DESK® NO HOLES MOUNT

Field proven over the past 20 years the Jotto Desk offers mobile professionals the best rugged laptop mount. Made of recyclable materials, our laptop workstation creates a proven mobile office for cars, trucks, vans, SUVs and Big Rigs. Jotto Desk is easy to install, easy to set-up and easy to use. From individuals to fleets this laptop mount will place your notebook at your fingertips when parked.



425-0020/4143



HEAVY DUTY NO HOLES MOUNT

- **Heavy Duty Motion Arm**
4.25" w x 0.75" thick x 9" long; black anodized
- **Upgraded Telescoping Rod**
1.75" x 6" steel with swing arm
- **Upgraded Stand**
2" x 15" .218 thickness, black; round stock
- **Height Variation**
15.875" to 19.875"
- **Upgraded Base Mount**
7 gauge steel, one-piece base



425-5693/4138

MAMBA MOUNT CONSOLE SIDE MOUNT

Jotto Desk is upgrading and simplifying your on-duty experience with the Mamba Mount, a console side mount designed to work in each zone; **Store & Drive, Park & Work, and Tactically Safe.**



425-0150/4138

BUILT TO FIT:

CONTOUR CONSOLE
425-6569



IPB CONTOUR CONSOLE
425-6678



D6S CONTOUR CONSOLE
425-6687



CONSOLE SIDE MOUNT

The JOTTO DESK® Console Side Mount (CSM) features No Holes Drilled installation on the passenger side of a compatible equipment console, preserving front passenger side leg room and improving performance. The CSM offers a straight arm which enables you to comfortably use and secure a laptop using the A-MOD or other desktop.



425-5542 / 4143

ZRT GUNS RACK

The ZRT Gun Racks are designed for any configuration you can imagine. Partition Mounted, Single Cell Mounted, Rear Seat Mounted or Free Standing, and Rear Hatch Mounted – Single Weapon or Dual.

- Eliminates 12V hot-wiring
- Cannot be defeated by magnets
- Zinc lock head design deforms instead of breaking
- Silicone inserts in lock head protect weapon from damage
- Quickly adjust AR side along the strong extruded backbone to accommodate various stocks
- Single or dual weapon
- Plug and play lock head/timer wiring
- Compact size - 1/3 smaller than other lock heads
- Innovative slide latch recesses inside housing when accessing firearm

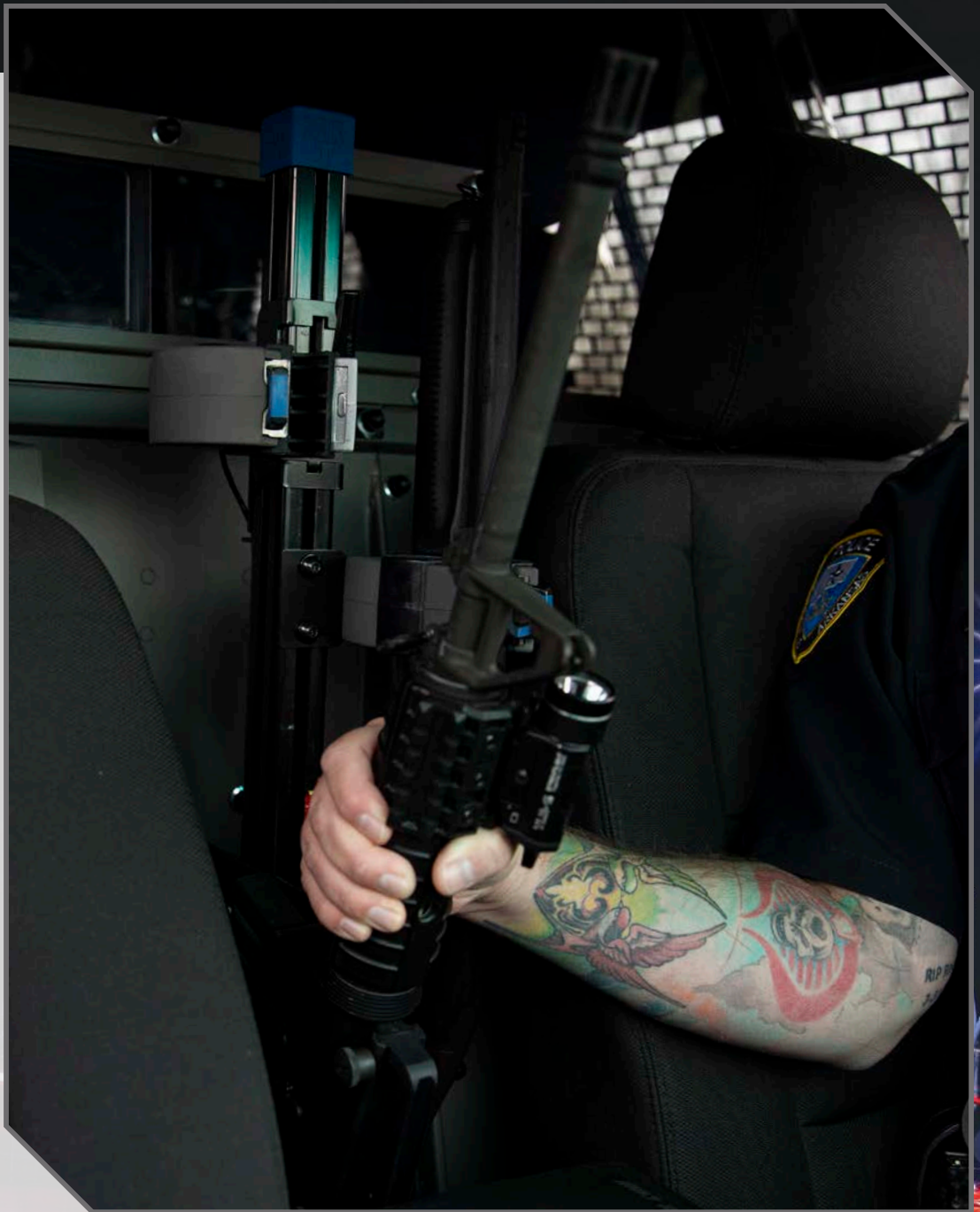

475-2010

SMARTLOCK TECHNOLOGY



U.S. PATENT NO. 8,910,560 AND U.S. PATENT NO. 10,563,943



SINGLE CELL MOUNT

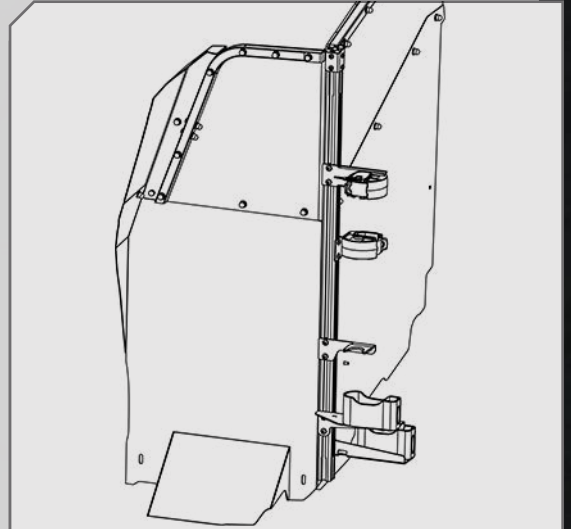

475-2049

REAR HATCH MOUNT

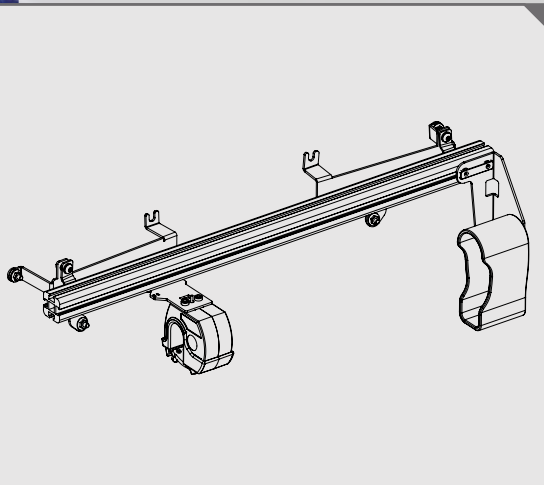

475-1788



Model #	Description	Location	Weapon	Style
475-2010	GR9, ZRT, AR BLM/870	Partition	Dual	Vertical
475-2063	GR9, ZRT, AR GL3-XL/870	Partition	Dual	Vertical
475-2015	GR9, ZRT, AR-BLM, V	Partition	Single (AR)	Vertical
475-2014	GR9, ZRT, 870, V	Partition	Single (870)	Vertical
475-2054	GR9, ZRT, AR-BLM	Partition	Dual (AR)	Vertical
475-2052	GR9, ZRT, AR SECURE-BLM/870	Partition	Dual (AR Secure)	Vertical
475-2053	GR9, ZRT, AR SECURE-BLM	Partition	Single (AR Secure)	Vertical
475-2049	GR7, ZRT, AR-BLM/870, TAHOE	Single Cell	Dual	Vertical
475-2050	GR7, ZRT, AR-BLM SIDEWAYS, TAHOE	Single Cell	Single (AR)	Vertical
475-1702	GR6, ZRT, AR-BLM/870, TAHOE 2021+	Rear Seat	Dual	Vertical
475-1788	GR4, ZRT, 870, TAHOE 2021+	Rear Hatch	Single (870)	Horizontal
475-1789	GR4, ZRT, AR-BLM, TAHOE 2021+	Rear Hatch	Single (AR)	Horizontal

VEHICLE PARTITIONS

Keep your officers and prisoners safe during transport with a Jotto Desk vehicle partition. Our system allows you to configure the partition to maximize the officer's workspace and our No Holes drilled installation is fast and easy.

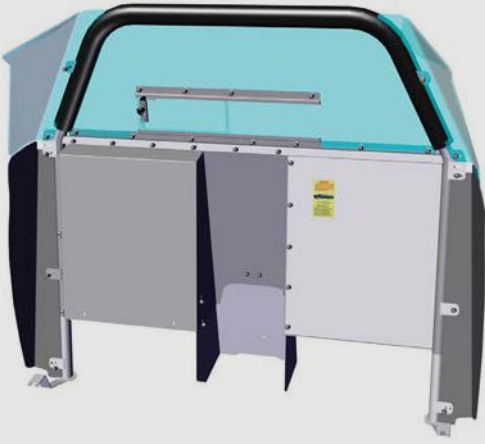

425-1657

SPACE CREATOR BDRH VEHICLE PARTITIONS (BIDIRECTIONAL RECESSED HOUSING)

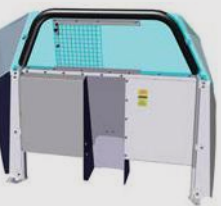

425-1675

Space Creator Vehicle Partitions transform previously unusable space to create additional leg room behind the front passenger seat. The BDRH creates unparalleled leg room for even large prisoners while maintaining excellent use of officer seat for complete comfort. (US Patent No. 8,690,216)



UDRH VEHICLE PARTITION (UNIDIRECTIONAL RECESSED HOUSING)

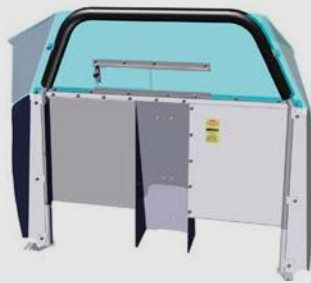

425-1677



425-1678



HSEP (HIGH SECURITY EXTENSION PANEL)

Enhance partition security by preventing rear passengers from reaching into the front of the vehicle under seats with a two-piece, steel High Security Extension Panel.

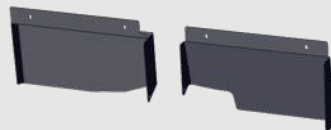

425-1674 (FITS BDRH)



425-1679 (FITS UDRH)

WINDOW ARMOR & DOOR PANELS

Protect your vehicles while transporting prisoners with Jotto Desk's line of Window Armor and Door Panels. The Window Armor is easy to install, prevents side windows from being kicked out and nobody can reach in or out of the prisoner compartment. Door Panels protect door mechanisms, prohibit contraband from being hidden, and are very easy to clean.

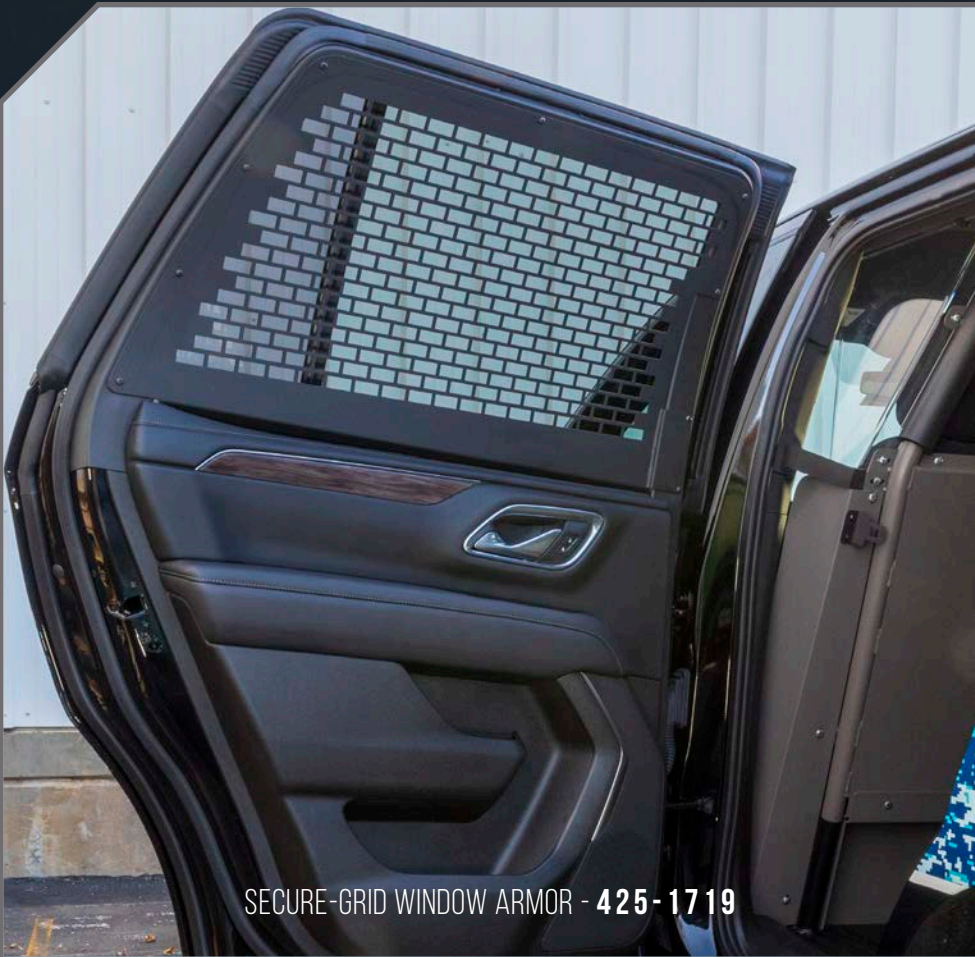

SECURE-GRID WINDOW ARMOR - 425-1719



SECURE GRID WINDOW ARMOR - 425-1719

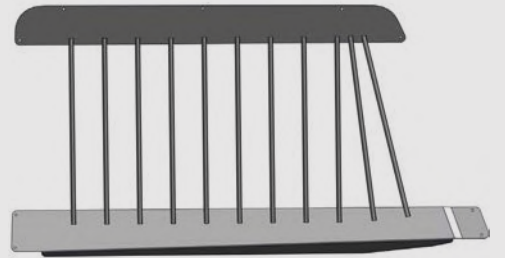

VERTICAL WINDOW ARMOR - 425-1718

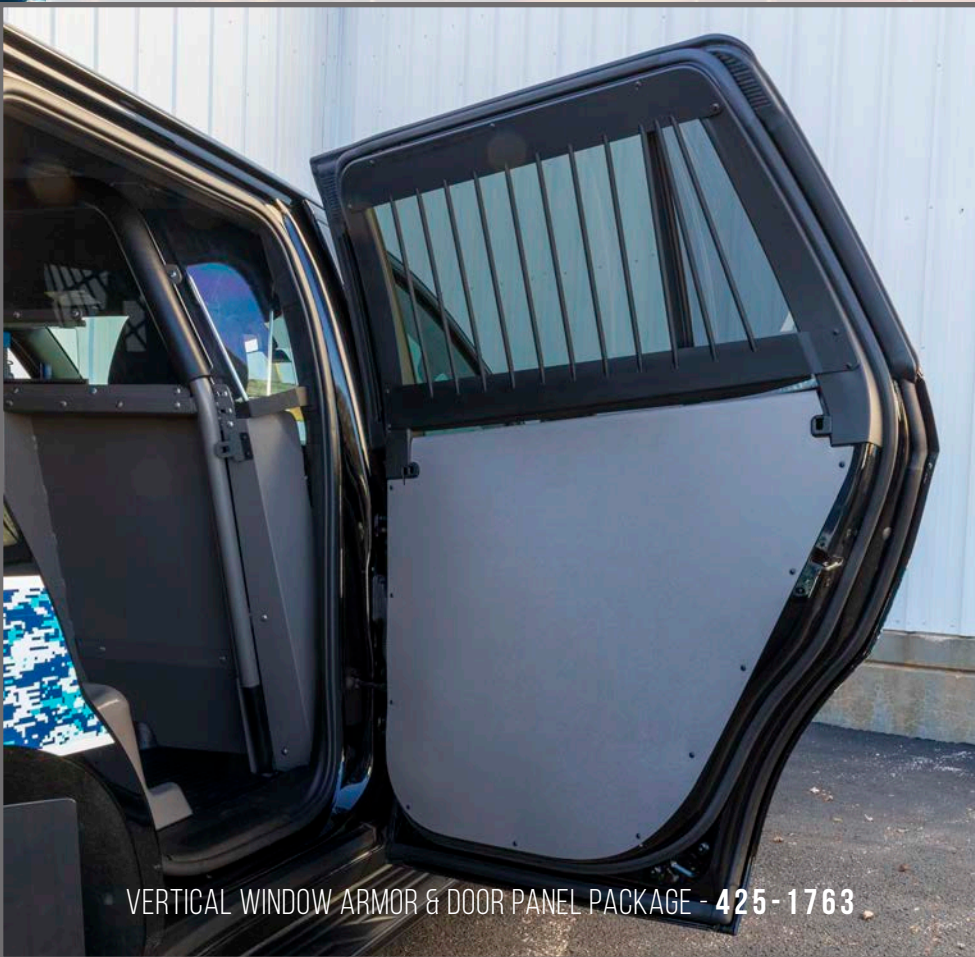

VERTICAL WINDOW ARMOR & DOOR PANEL PACKAGE - 425-1763



ABS DOOR PANELS - 425-1720

425-1711

SINGLE CELL

The Jotto Desk Single Cell includes the Front Divider, Center Divider, Rear Cargo Barrier (CB4), Passenger Side Window Armor, Passenger Side Door Panels, and ABS Seat Cover. Jotto Desk realized the extreme challenge facing agencies concerning the rear seat area of SUVs. The bottom 2/3 of the Front Divider is powder-coated steel with a built-in HSEP (High Security Extension Panel) for added prisoner foot room. We wanted to give the officer more observation possibilities of the prisoner, so the center divider has been updated. The upper polycarbonate portion sweeps down to allow for prisoner viewing/interaction, but does not diminish the driver's view out the rearview mirror. In fact, the visibility for an officer is nothing short of amazing.

Keep your cargo where it belongs with the included the CB4 Prisoner Cargo Barrier. This design secures behind the second row of seats in the (2021+) Chevy Tahoe PPV utilizing OEM mounting points. No cutting of trim is required and very minimal drilling is necessary. NOTE: CB4 Only Comes With Secure Grid

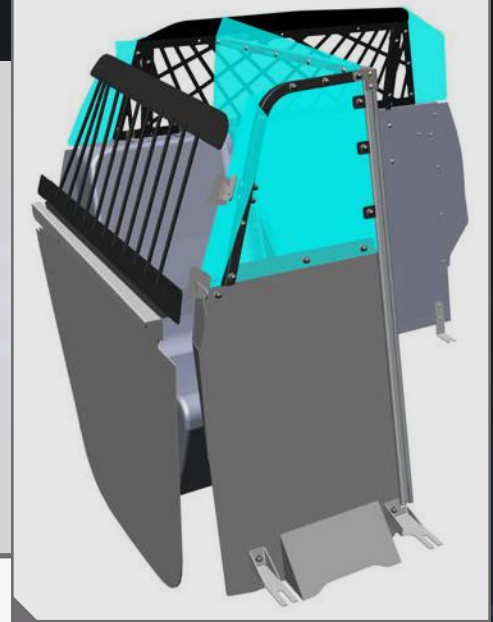

SINGLE CELL LITE

The Jotto Desk® Single Cell includes the Front Divider, Center Divider and SCA Compliant Rear Cargo Barrier (CB4). The bottom 2/3 of the front divider and center divider is powder coated steel with a HSEP for added prisoner foot room. We wanted to give officers a greater viewing angle of prisoners being transported, so the design was tweaked to increase the poly and reduce the steel.



475-1712

ABS SEATING

Jotto Desk realized the extreme challenge facing agencies in regard to the rear seat area of SUVs. The Jotto Desk solution, provides a complete SUV prisoner transport solution. The Replacement ABS Bio-Seat comes with all the hardware need to remove the OEM seat and replace with a biohazard and contraband control system for easier transportation and clean up. Along with replacing the OEM seat, Jotto Desk is offering a Door Side (DS) Seat Belt System.



475-1743



CARGO COVER/ EQUIPMENT TRAY

Introducing the Jotto Desk® 2021+ Chevy Tahoe Cargo Cover. Designed to provide a solid horizontal divider in the vehicle. The upper/top section creates an area for mounting expensive communication, in-car video, and lighting equipment that uninstalls easily for service. Retaining the lower section for the individual officer or deputy's day-to-day gear. Whether a Rubbermaid tote with crime scene tape, rubber gloves, and drug testing supplies or more mission-critical items like a sniper rifle, Level IIIA SWAT vest, and Kevlar Helmet. The Jotto Desk® 2021+ Chevy Tahoe Cargo Cover offers protection, first by obscuring from observation what is stored or housed underneath and secondly by relying on the strength of 14 gauge steel to keep anyone from stealing what is stored beneath the Cargo Cover.

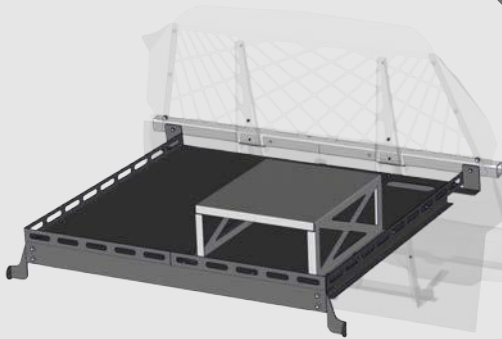

425-1850 (ATTACHES TO SRS)

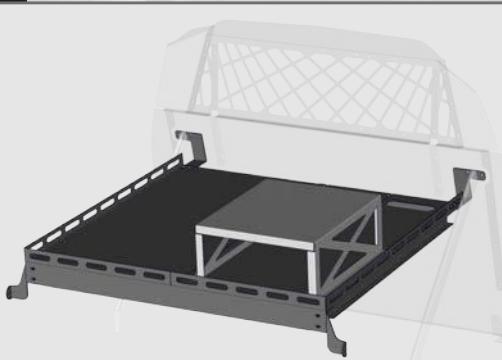

425-1851 (ATTACHES TO CB4)



CARGO BARRIERS

Separate the prisoner and the rear cargo areas securely with Jotto Desk's line of Cargo Barriers. Keep prisoners in their area and in case of a crash, keep your cargo where it belongs with the CB4 Prisoner Cargo Barrier. This design secures behind the second row of seats utilizing OEM mounting points, installs quickly and requires no vehicle modifications.

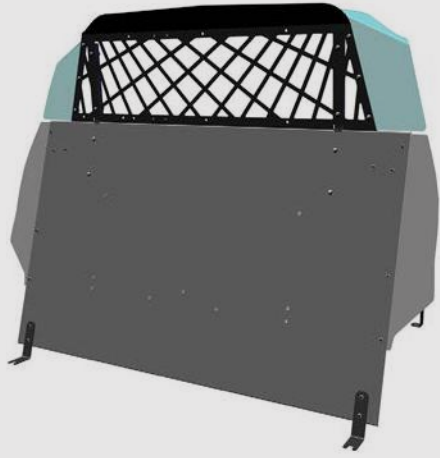

475-1682

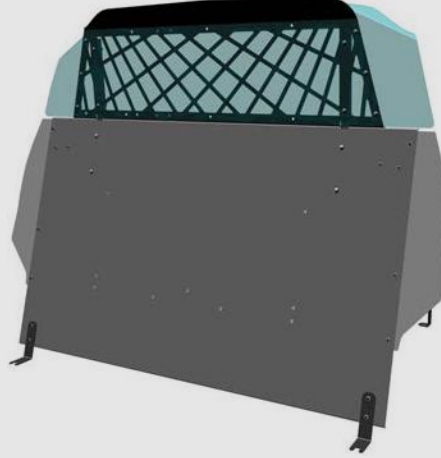

475-1709



CARGO BARRIER EQUIPMENT TRAY

The Cargo Barrier Equipment Tray provides a secure location to mount communications, lighting, and other equipment in the Tahoe cargo area. The Equipment Tray has been designed to mount directly to Jotto Desk Cargo Barriers (475-1682 & 475-1709) and the Cargo Barrier has been manufactured with PEM hardware to make installation a breeze. The steel construction of the equipment tray - helps protect the mounted equipment from damage due to unsecured items flying about when the vehicle is in motion. This solution makes initial upfits easy, as equipment can be bench mounted to the Removable Shelf and then mounted to the Equipment Tray. When servicing the mounted equipment - instead of doing everything in the confines of the cargo area, simply pull the Removable Shelf from the Equipment Tray and take into an air-conditioned room for repairs/replacement.

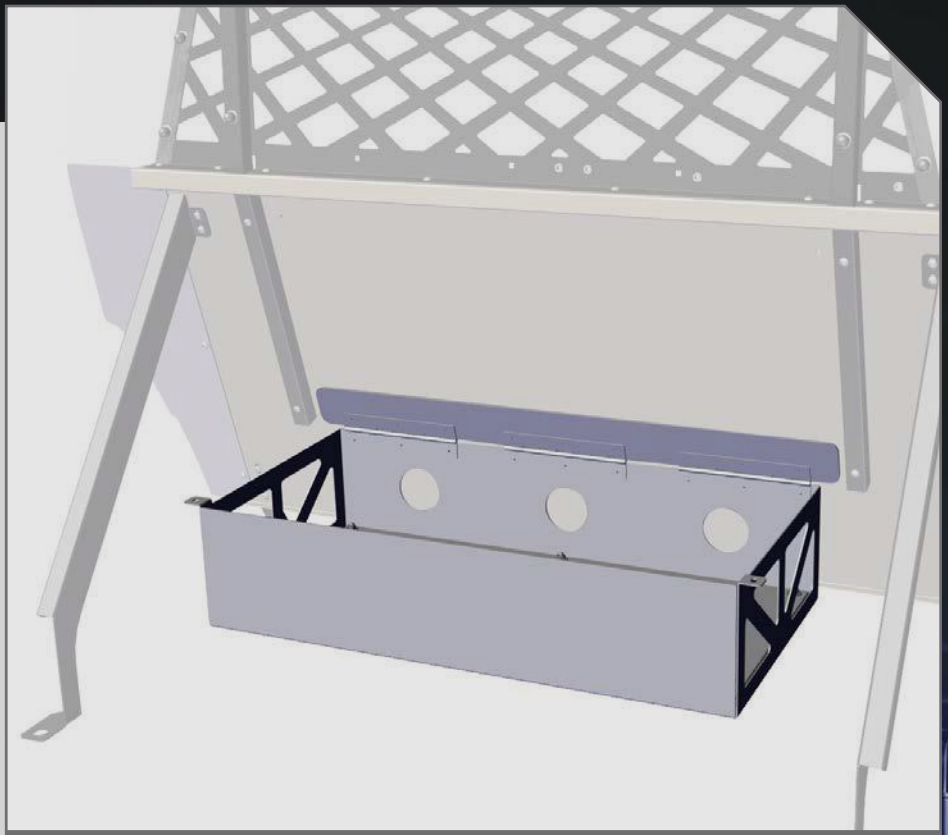

475-1709



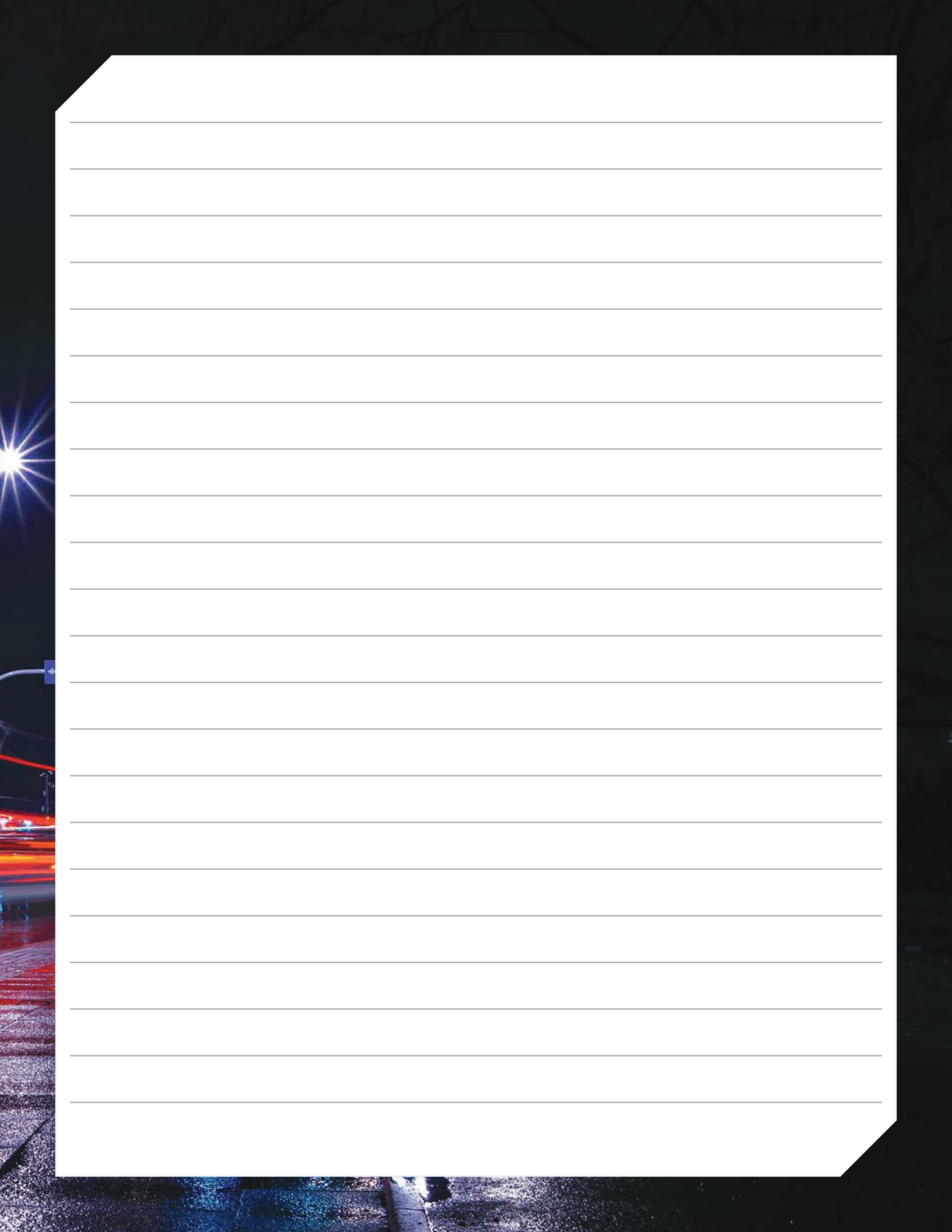

A large white rectangular area with a slightly irregular top and bottom edge, resembling a piece of paper. It contains 25 horizontal lines, evenly spaced, providing a template for writing or drawing.

TOTAL SOLUTIONS PROVIDER



209 W. EASY ST., ROGERS, AR 72756 • JOTTOPUBLICSAFETY.COM • 11/21

Jotto Desk® is a patented product and Registered Trademark of Assembled Products™ Corporation. Specifications subject to change without notice.